

POCKET AIR®

LoyalCare®



Elevate Your Respiratory Care  
MB05T01

MICROBASE®

# MICROBASE®

Originating in Taiwan,  
Elevating healthcare standards.

Over one million units have been sold worldwide and strong partnerships with top pharmaceutical companies.

MicroBase Technology Corporation was founded in 1997 in Taiwan. MicroBase is dedicated to develop "non-silicon-based MEMS " by using LIGA technology that could development of miniaturized devices and micron-scale parts. After a decade of development we are the only company in the Asia with the capabilities of laser material processing and mass production all in one. MicroBase has applied to produce in many different fields including electronic peripherals, medical materials and beauty products all over the world.

ISO9001, ISO13485, ISO17025 certifications ensure our commitment to safe, reliable, convenient, comfortable and efficient.

With Laser-LIGA technology, MicroBase has process micron-level microstructures for various materials and incorporated the micro mesh technique into the development of inhalation devices, POCKET AIR®, for the treatment of respiratory diseases. We are dedicated to providing drug delivery system to all the patients and the healthcare professionals. We welcome collaboration opportunities in developing combination products with pharmaceutical companies.

The laboratory has passed the evaluation by International Laboratory Accreditation Alliance (ILAC) since 2017, and obtained the ISO17025 laboratory certification. Data reports issued by the laboratory have the credibility of third-party certification, including the EU and the US FDA. The nebulizer can provide more practical scientific data on the performance of different drugs to accurately monitor the quality of products.



NATIONAL MEDICAL PRODUCTS ADMINISTRATION

# Medication Cup

- Single patient single use.
- Smooth angle design close to zero liquid residue, completely atomized and absorbed.
- Double-use design for the upper cover-refill medication and protect the circuit.



# Unique PI mesh

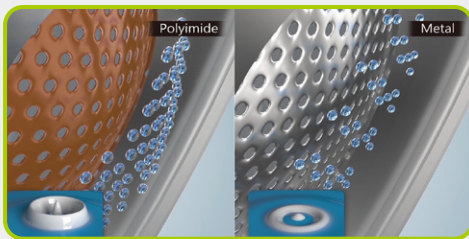

**PZT**  
Vibrational Element  
**Mesh**  
Aperture Plate

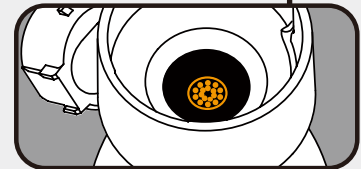
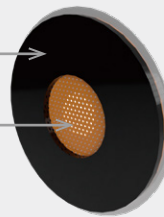

- Polyimide Mesh has excellent biocompatibility, durability and corrosion resistance which result a higher safety on different drugs and applications.

# USB Controller

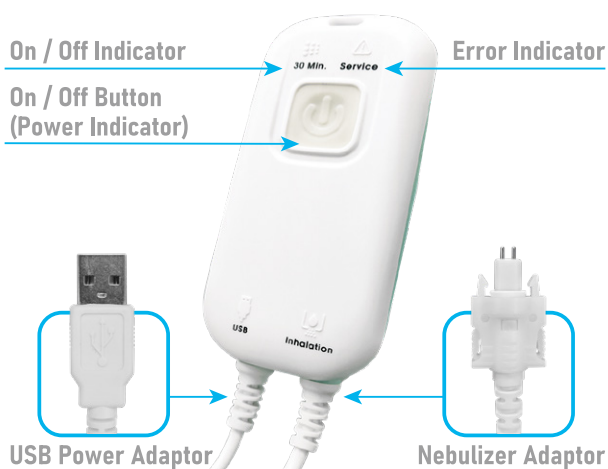

- Easy use one button control and 4 steps installation.
- Two ways use in hospital environment.
- Automatically power off within 30 minutes

# T-Piece

Conical connector requires ISO 5356-1 Anesthetic and Respiratory Equipment – Conical Connectors.

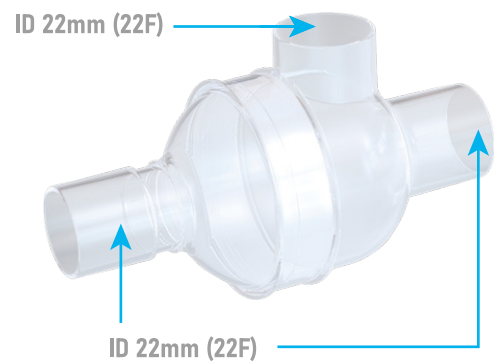

- Can be placed at the wye or at the humidifier.
- PP material heat resistance and no Bisphenol A.
- Spherical T-Piece cavity increases the amount of drugs directly to the lungs.

## Two Ways Use For Hospital Enviroment

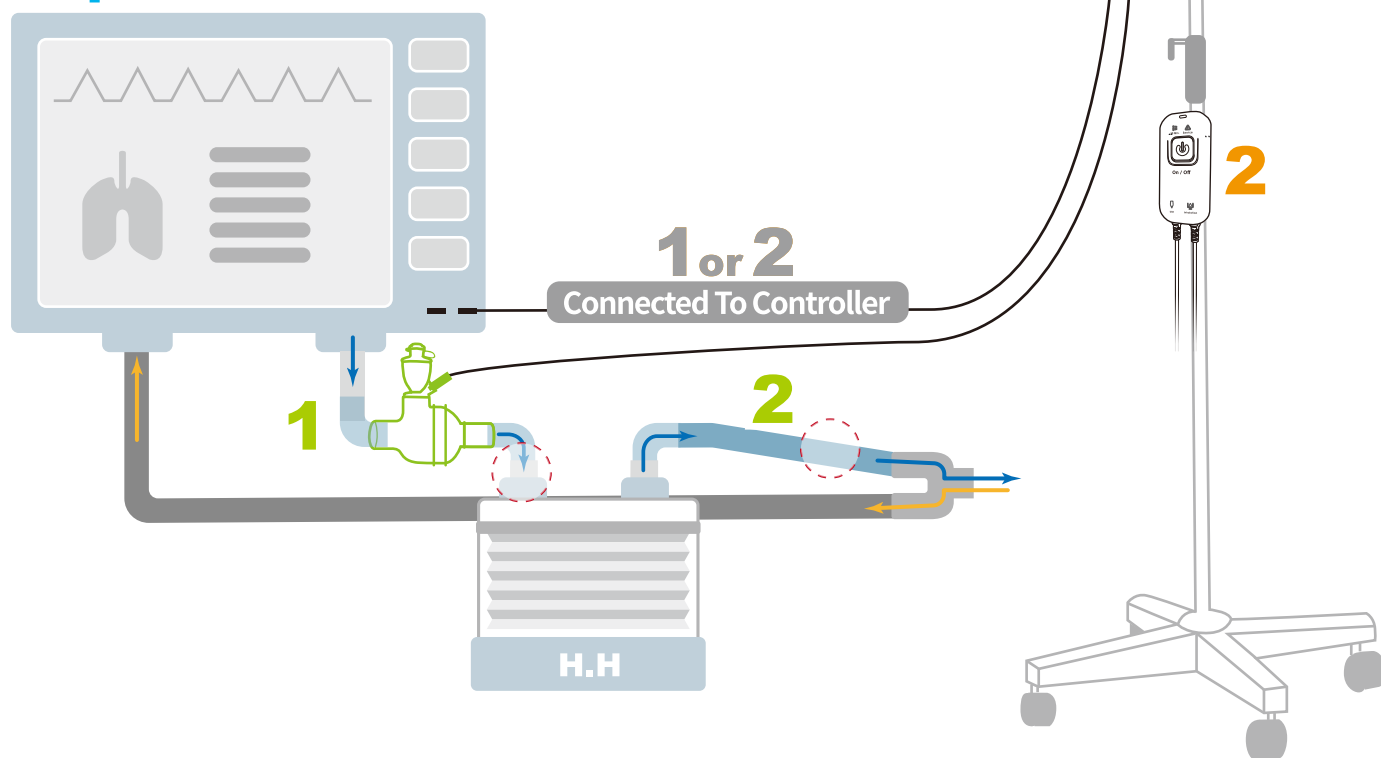

### 1. Connect With Humidifier

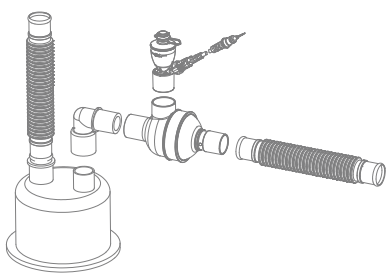

### 2. Connect With Breathing Circuit

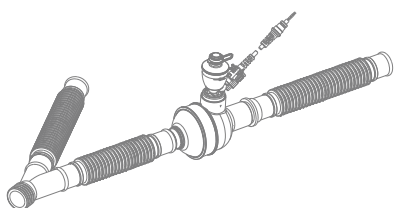

### 1. USB Power Adaptor

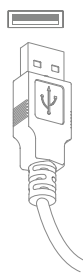

### 2. Connect the AC/DC Adapter to the power outlet.

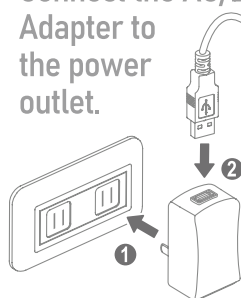

### 1. Hole on the Top



### 2. Hole on the back cover



## High-Flow Therapy

Fits in-line with no added flow and no interruption of therapy during administration of medication.

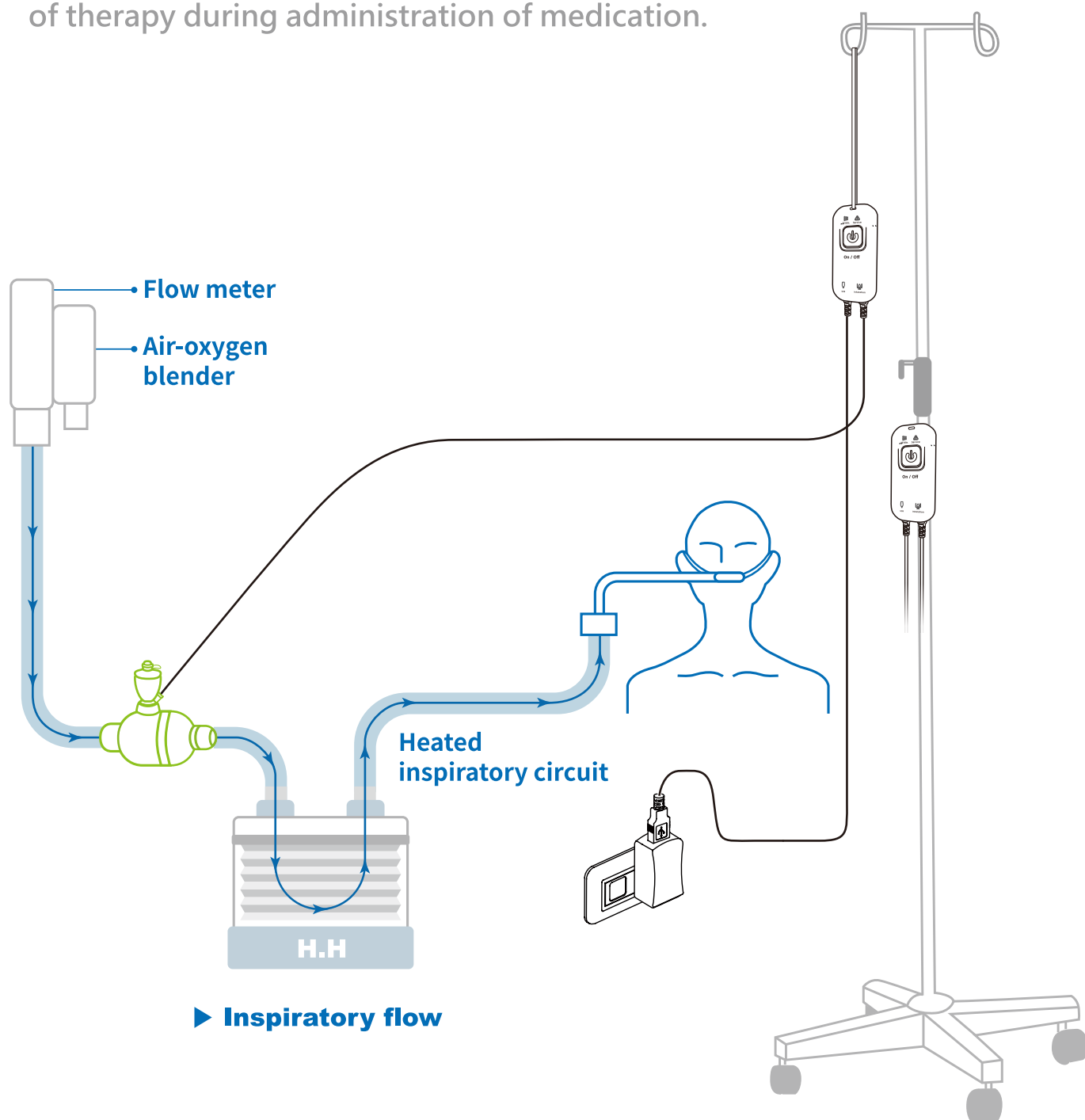



## Specifications

Model	MB05T01
Method Of Operation	Active Vibrating Mesh Technology
Power Supply	Power Adapter: -Please use a power adapter that meets the requirements of IEC60601-1 and CCC certification standards. -Specification: 5V DC, 1A
Vibrating Frequency	Approx. 120 (kHz) ± 15%
Nebulization Rate	≥ 0.2 mL / min
Particle Size	MMAD ≤ 5µm
Capacity Of Medication Cup	Approx. 6ml
Intended user	29 days Neonatal or older and adult. Operator must be legally practicing medical personnel.
Operation Environment	Temperature 10°C to 40°C, Humidity 30 to 85% RH, Air pressure: 800 - 1060hPa
Storage and Transportation Environment	Temperature -20 - 70°C, Humidity 20 - 75%, Air pressure: 800 - 1060hPa
Using time	28 days (4 treatments per day).
Weight	USB Controller Approx 100g Medication cup Approx 65g
Product Contents	USB Controller, T-Piece, Nebulizer and Adapter.



# MICROBASE<sup>®</sup>

TECHNOLOGY CORP.



+886-3-376-7555



sales@microbasetech.com

No.756,758 Jiadong Rd., Bade Dist., Taoyuan City,334015, Taiwan